

Realiza ocho cubos iguales.

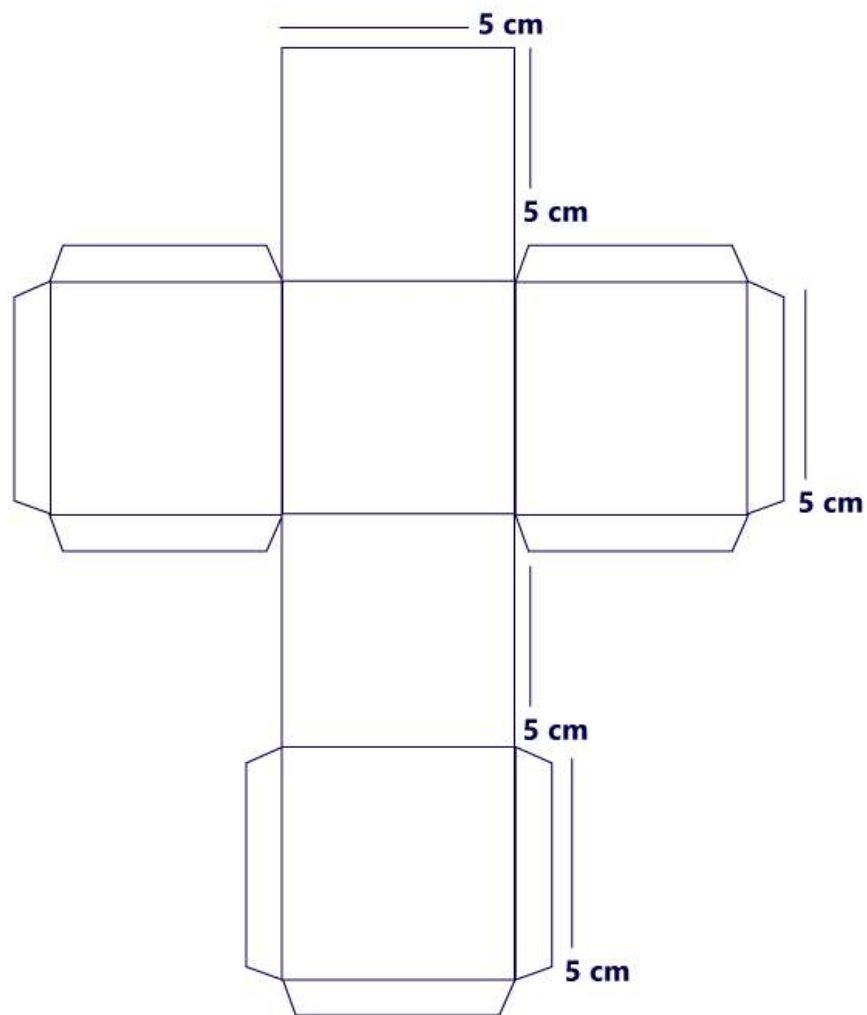

Origami

Expresa
tu creatividad

----- Cubo infinito -----

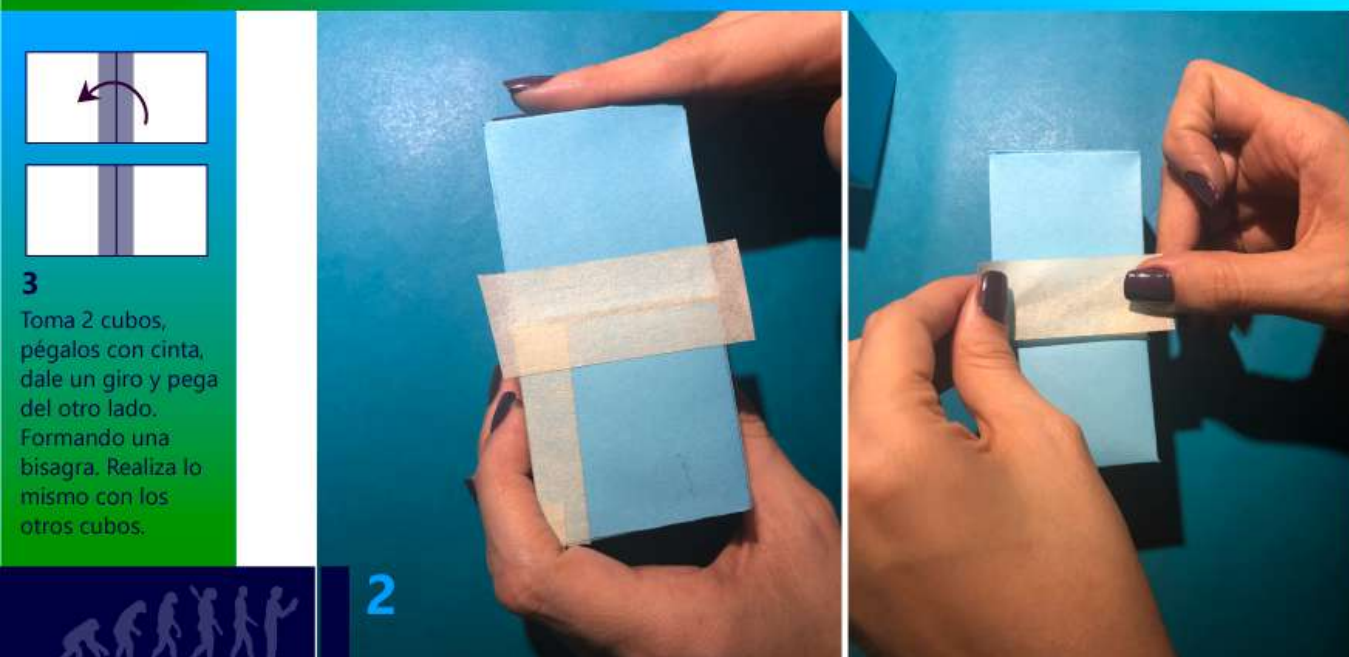
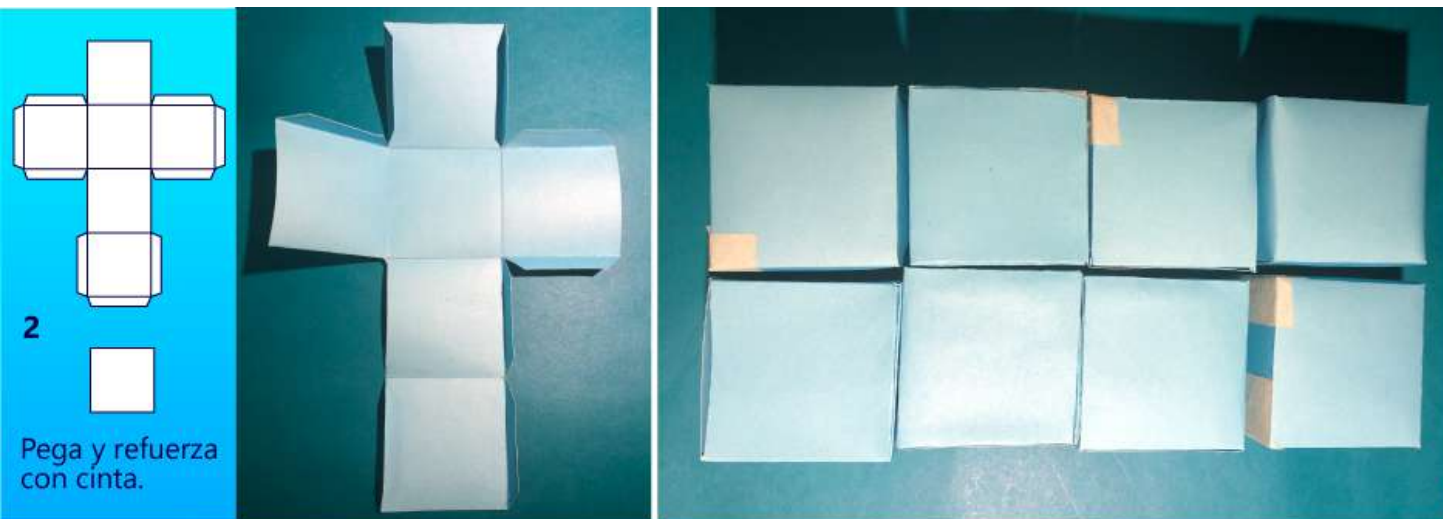

Origami

Expresa
tu creatividad

----- Cubo infinito -----

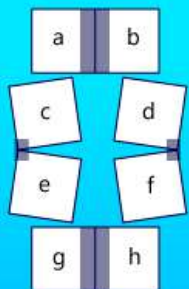

2
Ordénalos de esta forma.

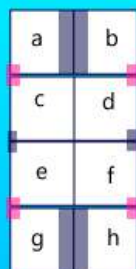

3 Pega como bisagra:
- a y c
- b y d
- e y g
- f y h

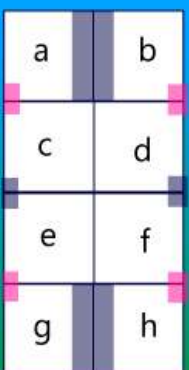
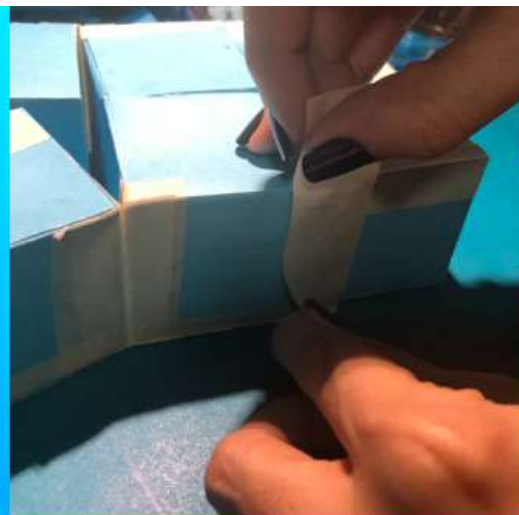

4



Origami

Expresa
tu creatividad

----- Cubo infinito -----