

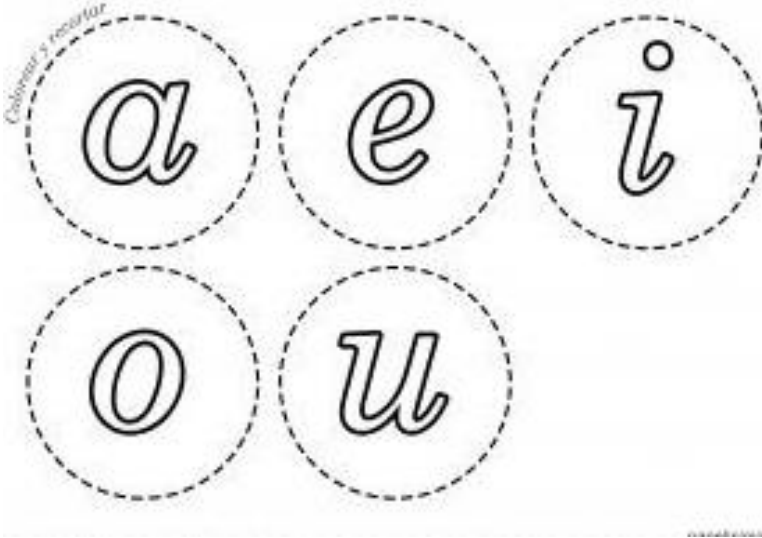

1. Escribe tú nombre completo 5 veces.

2. Colorea las vocales en minúscula



3. Pronuncia el nombre de cada dibujo y escribe su vocal inicial.

¿Por qué letra empiezan estos dibujos?

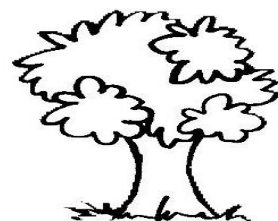
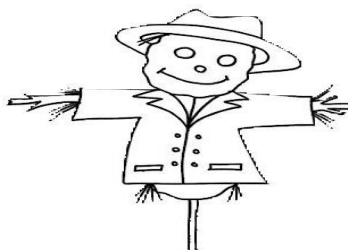
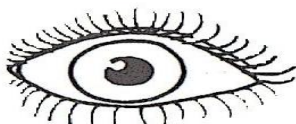
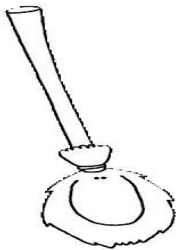
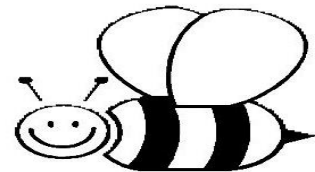
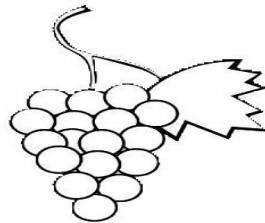
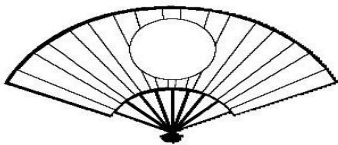

4. Completa la escritura de las siguientes palabras.

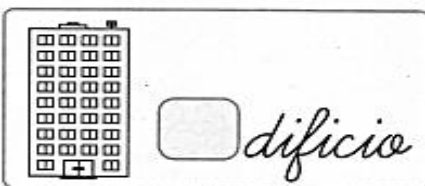
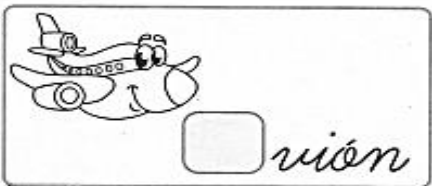
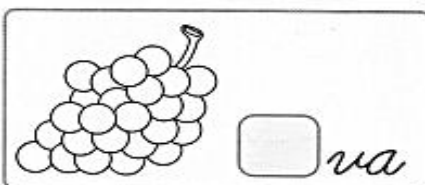
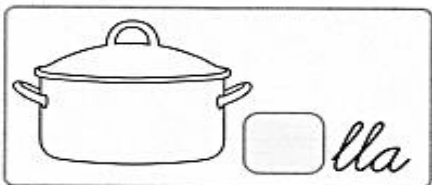
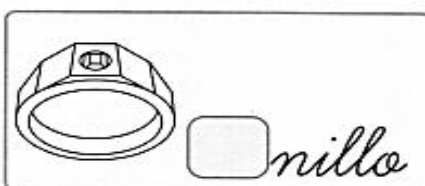
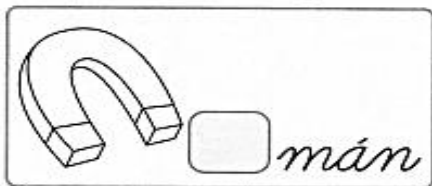
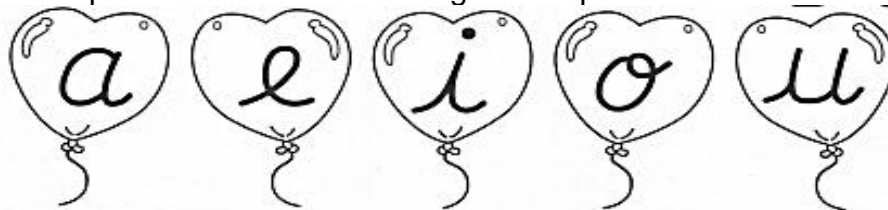

5. Completa la escritura de las siguientes palabras, colocando las vocales.

¿QUÉ VOCALES TIENEN?



C _ R _ C _ L



S _ LT _ M _ NT _ S



_ RB _ L







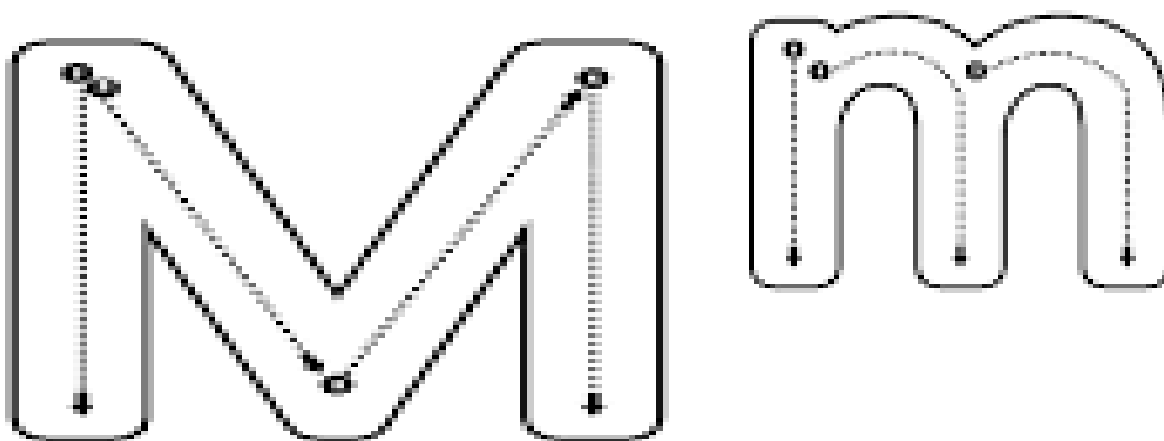







H _ J _

6. Colorea la letra m en mayúscula y minúscula.



7. Escribe a cada dibujo la sílaba por la cual empieza (ma- me- mi- mo- mu)

	<input type="text"/>		<input type="text"/>
	<input type="text"/>		<input type="text"/>
	<input type="text"/>		<input type="text"/>
	<input type="text"/>		<input type="text"/>
	<input type="text"/>		<input type="text"/>
	<input type="text"/>		<input type="text"/>

8. Escribe 10 palabras que contengan solo la letra m.

-	-
-	-
-	-
-	-
-	-

9. Dibuja y colorea la letra P.

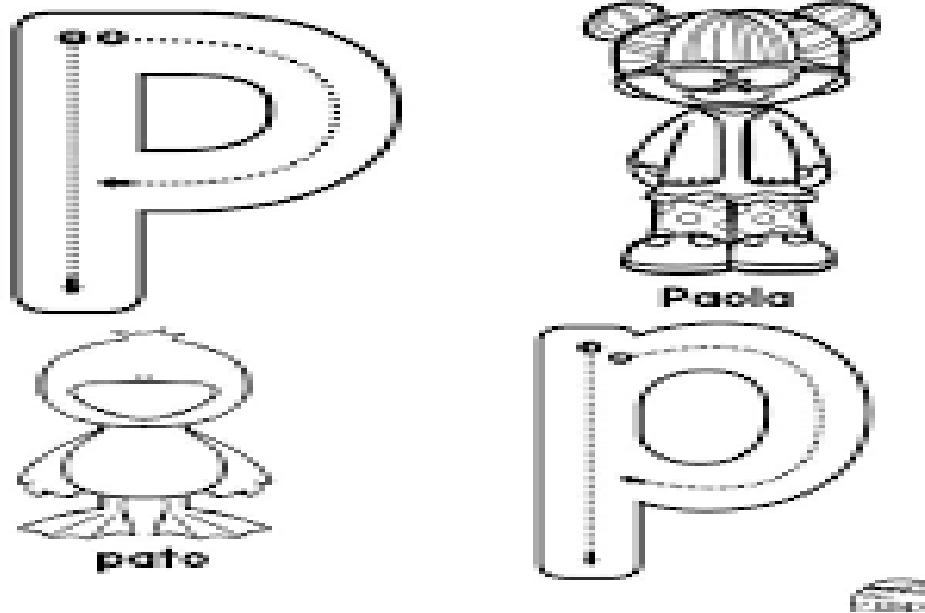

10. Escribe el nombre de los siguientes dibujos con la letra P.



11. Escribe la sílaba que hace falta para completar cada palabra.

 __leta	 __rro	 __e
 __zo	 __po	 __pá
 __lota	 __ano	 __llo